

Manual Accessories

Hex Head Spindle – Stainless Steel

- Includes Plain hexagonal head
- Includes Fully threaded
- Includes Stainless steel, type 303
- Includes Includes jam nuts

Part No.	M	L	L1	SW	H	Part No.	M	L	L1	SW	H
● 205943-M	M4	[0.89] 22	[0.79] 20	[0.28] 7	[0.09] 2,2	▲ 205943	#8-32	[0.86] 21,8	[0.75] 19,1	[0.25] 6,4	[0.13] 3,2
● 201943-M	M5	[1,32] 33,5	[1.18] 30	[0.31] 8	[0.11] 2,7	▲ 201943	#10-32	[1,37] 34,8	[1,37] 34,8	[0.31] 8	
● 202943-M	M6	[1.73] 42,4	[1.57] 40	[0.39] 10	[0.13] 3,2	▲ 202943	1/4-20	[1.67] 42,4	[1.50] 38,1	[0.44] 11,1	[0.16] 4
● 207943-M	M8	[2.77] 70,3	[2.56] 65	[0.51] 13	[0.16] 4	▲ 207943	5/16-18	[2.72] 69	[2.50] 63,5	[0.50] 12,7	[0.19] 4,8
● 237943-M	M10	[3.00] 76,4	[2.76] 70	[0.67] 17	[0.20] 5	▲ 237943	3/8-16	[2.75] 69,9		[0.56] 14,2	[0.22] 5,6
● 245943-M	M12	[2.87] 73	[2.56] 65	[0.75] 19	[0.24] 6	▲ 245943	1/2-13	[2.72] 69	[2.38] 60,5	[0.75] 19,1	[0.31] 8

Hex Head Spindle

- Plain hexagonal head
- Fully threaded
- Zinc plated
- Includes jam nuts

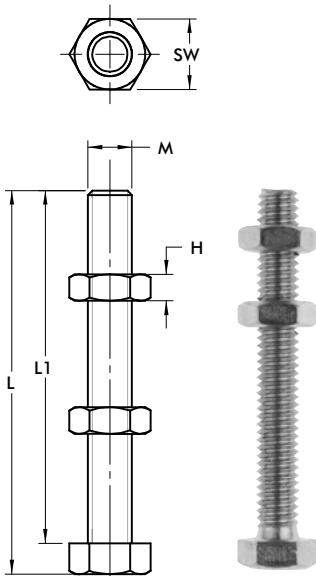

Part No.	M	L	L1	SW	H	Part No.	M	L	L1	SW	H
● 205203-M	M6	[1.93] 49	[1.77] 45	[0.39] 10	[0.13] 3,2	▲ 205203	1/4-20	[1.92] 48,8	[1.75] 44,5	[0.44] 11,2	[0.16] 4
▲ 461203-M	M8	[1.20] 30,5	[0.98] 25	[0.51] 13	[0.16] 4	▲ 202203		[3.17] 80,5	[3.00] 76,2		
● 207203-M		[2.97] 75,5	[2.76] 70			▲ 461203	[1.22] 31	[1.00] 25,4			
▲ 491203-M	M10	[1.85] 47	[1.57] 40			▲ 441203	5/16-18	[1.97] 50	[1.75] 44,5	[0.50] 12,7	[0.19] 4,8
● 210203-M		[3.03] 77	[2.76] 70	[0.67] 17	[0.20] 5	▲ 207203		[2.72] 69,1	[2.50] 63,5		
▲ 240203-M		[4.21] 107	[3.94] 100			▲ 491203		[1.75] 44,5	[1.50] 38,1		
● 220203-M	M12	[3.46] 88	[3.15] 80	[0.75] 19	[0.24] 6	▲ 210203	3/8-16	[3.00] 76,2	[2.75] 69,9	[0.56] 14,2	[0.23] 5,8
● 267203-M	M16	[5.12] 130	[4.72] 120	[0.94] 24	[0.28] 7	▲ 240203		[4.25] 108	[4.00] 101,6		
▲ 105203*	#8-32	[0.86] 21,8	[0.75] 19,1	[0.25] 6,4	[0.13] 3,3	▲ 527203		[5.25] 133,4	[5.00] 127		
▲ 305203	#10-32	[1.12] 28,4	[1.00] 25,4	[0.31] 8		▲ 325203	1/2-13	[2.84] 72,1	[2.50] 63,5	[0.75] 19,1	[0.31] 7,9
						▲ 220203		[3.34] 84,8	[3.00] 76,2		
						▲ 250203	5/8-11	[4.42] 101,6	[4.00] 9,5	[0.38] 9,5	[0.38] 9,5

*Material: nylon

Preferred Market: ▲ NA/SA ■ Europe ● Global