

Bar-Style Product Overview

Features:

These rugged clamps, made from high-tensile, heat-treated steel, are designed for all types of applications requiring large holding capacities from 1270 lbf to 6000 lbf (5650N to 27000N). The clamps are highly versatile. For example, jaws can be reversed to provide spreading action, or several jaws can be used on a single bar both for fixturing and positive component location and clamping.

Available models include T321 Standard-Duty Deep Throat, T285 Medium-Duty Deep Throat, T186 Standard-Duty, T290 Medium-Duty and T257 Heavy-Duty. In addition, standard and medium-duty connectors are available to couple like bars together for increased clamping reaches.

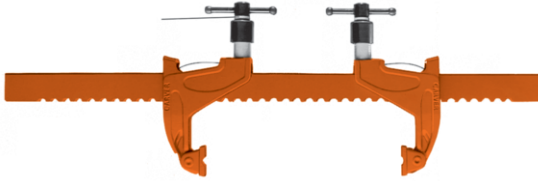

Model	For Bar Clamps Model	Weight [lbs.] kg
T186-13	T186-... and T321-...	[1.54] 0,7
T290-13	T285-... and T290-...	[2.87] 1,3

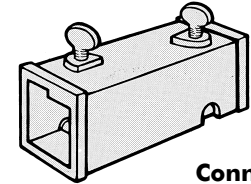

Connector

Bar-Style Technical Information, Holding Capacities

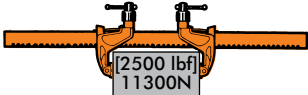
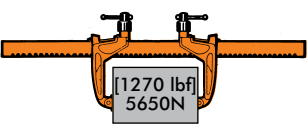
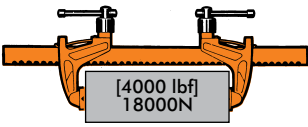
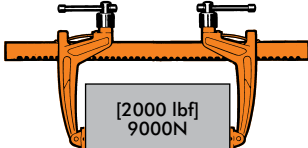
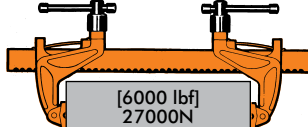
Holding Capacity	Throat Depth	Width Opening S		Width Opening S1		Model	Clamping Screw Ø	Weight [lbs.] kg	Consisting of:	
		min	max	min	max				1x	2 x
 [2500 lbf] 11300N	[2.38] 60	[8.50] 215	[24] 600	[2.95] 75	[26.8] 680	T186-24 T186-36	M12	[7.50] 3,4	186-24-1	186-2
			[36] 900		[39] 990			[9.50] 4,4	186-36-1	
 [1270 lbf] 5650N	[4.7] 120	[5.50] 140	[24] 600	[3.15] 80	[27.2] 690	T321-24 T321-36 T321-60	M12	[7.70] 3,5	186-24-1	321-2
			[36] 900		[39.4] 1000			[9.00] 4,5	186-36-1	
			[60] 1500		[63] 1600			[13.00] 5,9	186-60-1	
 [4000 lbf] 18000N	[3.5] 90	[10.00] 250	[36] 900	[4.72] 120	[36.9] 1005	T290-36 Ⓢ T290-60 Ⓢ T290-84	M16	[20.50] 10,5	290-36-1	290-2
			[48] 1200		[63.8] 1620			[28.50] 14,0	290-60-1	
			[60] 1500		[87.4] 2220			[36.50] 18,0	290-84-1	
 [2000 lbf] 9000N	[8.0] 200	[6.00] 150	[36] 900	[4.72] 120	[42.7] 1085	T285-36 Ⓢ T285-60 Ⓢ T285-84	M16	[24.50] 10,5	290-36-1	285-2
			[48] 1200		[66.93] 700			[32.50] 15,0	290-60-1	
			[60] 1500		[90.6] 2300			[40.50] 19,0	290-84-1	
 [6000 lbf] 27000N	[4.5] 115	[12.00] 305	[84] 2100	[5.90] 150	[86.6] 2200	Ⓢ T257-84	M20	[61.00] 27,2	257-84-1	257-2

Ⓢ Available upon request

Bar-Style Technical Information, Holding Capacities, Standard Clamp Dimensions

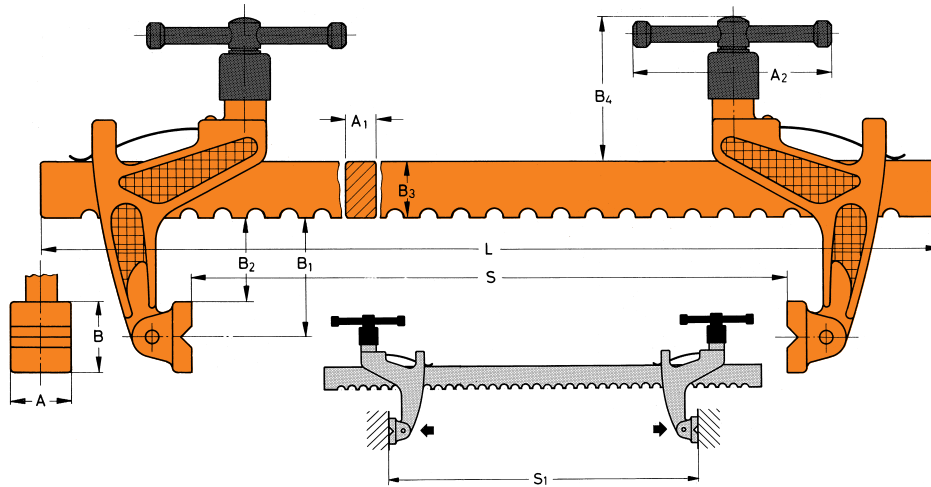

Model	[inch] mm							
	A	A1	A2	B	B2	B3	B4	L
T186-24								[28] 710
T186-36	[0.98] 25	[0.47] 12	[2.99] 76	[1.26] 32	[1.73] 44	[1.18] 30	[2.99] 76	[40.2] 1020
T321-24								[28] 710
T321-36	[0.98] 25	[0.47] 12	[2.99] 76	[1.26] 32	[4.09] 104	[1.18] 30	[2.99] 76	[40.2] 1020
T321-60								[64] 1625
T290-36								[42.1] 1070
Ⓢ T290-60	[1.50] 38	[0.79] 20	[5.51] 140	[2.00] 51	[2.56] 65	[1.57] 40	[4.13] 105	[66.5] 1690
Ⓢ T290-84								[90.2] 2290
T285-36								[42.1] 1070
Ⓢ T285-60	[1.50] 38	[0.79] 20	[5.51] 140	[2.00] 51	[7.09] 180	[1.57] 40	[4.13] 105	[66.5] 1690
Ⓢ T285-84								[90.2] 2290
Ⓢ T257-84	[2.00] 51	[0.87] 22	[7.36] 187	[2.50] 63,5	[3.27] 83	[2.05] 52	[5.00] 127	[91.9] 2335

Ⓢ Available upon request