

Series 305, 307, 309 Product Overview

Features:

- Compact design suitable for use in confined spaces
- Available with DE-STA-CO® Toggle Lock Plus
- Stainless steel models available

Applications:

- Assembly & Test
- Light Machining
- Closures
- Woodworking

Also Available:

See page 8.1 for accessories

305-U
Flanged Base
U-Bar

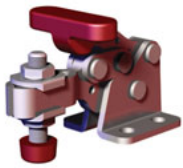

305-USS
Flanged Base
U-Bar, Stainless
Steel

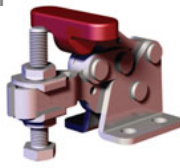

305-UR
Flanged Base,
U-Bar with
DE-STA-CO®
Toggle
Lock
Plus

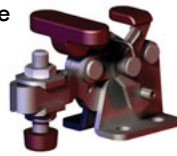

307-U
Flanged Base
U-Bar



307-USS
Flanged Base
U-Bar, Stainless
Steel



307-UR
Flanged Base,
U-Bar with
DE-STA-CO®
Toggle
Lock
Plus



309-U
Flanged Base
U-Bar



309-USS
Flanged Base
U-Bar, Stainless
Steel

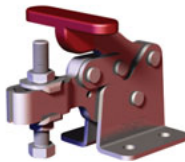

309-UR①
Flanged Base,
U-Bar with
DE-STA-CO®
Toggle
Lock
Plus



Note:
Clamps shown with included accessories.

Series 305, 307, 309 Technical Information

Model	Max. Holding Capacity	Clamp Bar Opening (+10°)	Handle Opening (+10°)	Weight	Accessories (Supplied)	
					Spindle Assembly	Flanged Washers
305-U	670 N [150 lbf]	90°	170°	0,06kg [0.13lb]	305208-M	102111
305-USS	900 N [200 lbf]				201943	102911
305-UR	670 N [150 lbf]				305208-M	102111
307-U	1560 N [350 lbf]	92°	173°	0,24kg [0.54lb]	307208-M	507107
307-USS					207943	507907
307-UR					307208-M	507107
309-U	3340 N [750 lbf]	90°	168°	1,30kg [0.59lb]	309208	235106
309-USS					237943	235906
309-UR①					309208	235106

① This item is available upon request

Series 305, 307, 309 Holding Capacities

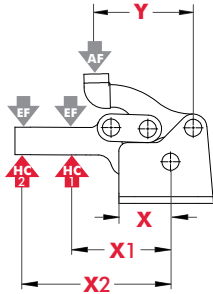

Model	X	X1	X2	Y	±HC1	±HC2	±EF(X1):AF	±EF(X2):AF
305-U/UR	[0.58]	[1.38]	[1.88]	[1.14]	[150lbf.] 670N	[110lbf.] 490N	3:1	2:1
305-USS	14,6	35	47,7	29	[200lbf.] 900N	[150lbf.] 670N		
307-U/UR/USS	[0.94]	[1.88]	[2.50]	[1.77]	[350lbf.] 1560N	[260lbf.] 1160N	4:1	
309-U/UR/USS	[1.34]	[2.50]	[3.50]	[2.70]	[750lbf.] 3340N	[530lbf.] 2360N		

Dimensions shown "mm [inch]" ± HC = Holding Capacity, EF = Exerting Force, AF = Applied Force
Refer to page 20.4 for additional information.

Series 305, 307, 309 Standard Clamp Dimensions -U/-USS/-UR

305-U[†]
Flanged Base
U-Bar

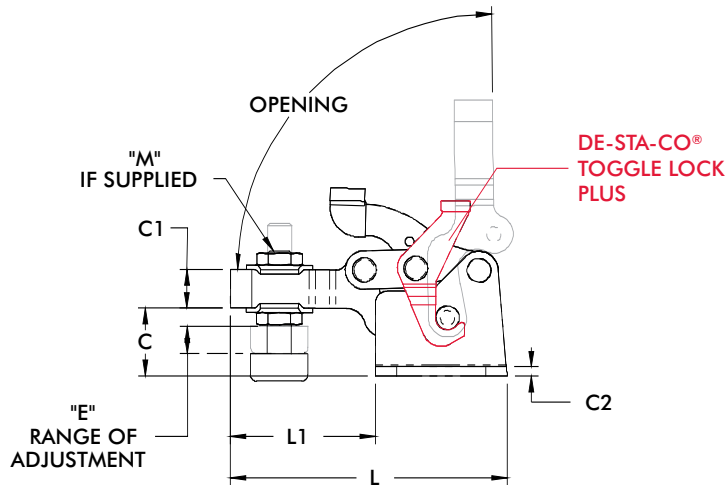
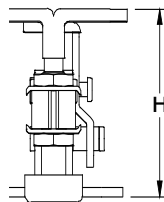
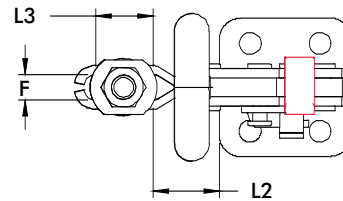
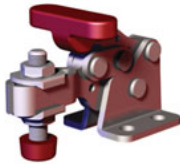

307-UR[†]
Flanged Base,
U-Bar with
DE-STA-CO[®]
Toggle
Lock
Plus

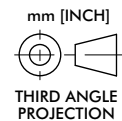
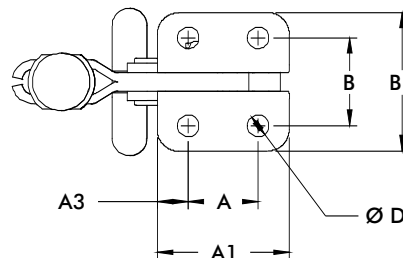

Model	A	A1	A3	B	B1	C	C1	C2	D	F	H	L	L1	L2	L3	M
305-U/UR	[0.53] 13,5	[1.035] 26,3	[0.25] 6,4	[0.63] 16,0	[1.02] 25,9	[0.48] 12,2	[0.31] 7,9	[0.08] 2,0	[0.18] 4,6	[0.21] 5,3	[1.43] 36,3	[2.21] 56,1	[1.19] 30,2	[0.51] 13,0	[0.50] 12,7	[#10] M5
307-U/UR	[0.91] 23,1	[1.72] 43,7	[0.40] 10,2	[1.14] 29,0	[1.80] 45,7	[0.89] 22,6	[0.50] 12,7	[0.12] 3,0	[0.28] 7,1	[0.33] 8,4	[2.36] 59,9	[3.61] 91,7	[1.89] 48,0	[0.86] 21,8	[0.75] 19,1	[5/16] M8
309-U/UR	[1.38] 35,1	[2.52] 64,0	[0.58] 14,7	[1.50] 38,1	[2.47] 62,7	[1.31] 33,3	[0.75] 19,1	[0.12] 3,0	[0.33] 8,4	[0.44] 10,4	[3.53] 89,7	[5.19] 131,8	[2.68] 68,1	[1.28] 32,5	[1.06] 26,9	[3/8-16] M10